

TEMPTECH

Wine Coolers USER MANUAL

SKX6070DRB
SKX6070DKF

*This manual contains important information including **safety and installation instructions** of the appliances. Please read it carefully before use and follow all safety information & instructions. It is recommended to keep this manual for easy reference so that you can be familiar with the operation of the appliance.*

--CONTENTS--

01 ENERGY SAVING AND ECOLOGICAL PROTECTION

02 IMPORTANT SAFETY INFORMATION

05 SCRAPPING OLD APPLIANCES

- 05 Conformity
- 05 Energy Saving
- 06 Service

06 INSTALLATION

- 06 SKX6070DKF
- 07 SKX6070DRB

07 ACCESSORY INSTALLATION BEFORE OPERATING

- 07 UNPACKING AND CLEANING THE WINE COOLER
- 07 Adjusting the height and levelling off your wine cabinet

09 BOTTLE LOADING DRAWING

- 09 SKX6070DRB/DKF

10 OPERATING THE WINE COOLER

- 10 WORKING CLIMATE
- 10 WINE STORAGE

11 CONTROL PANEL IN CABINET

- 11 Dual zone control panel
- 11 POWER ON/OFF CONTROL
- 11 LOCKING/UNLOCKING THE CONTROL PANEL
- 12 TEMPERATURE SETTING
- 12 TEMPERATURE DISPLAY (SET TEMPERATURE DEFAULT)
- 12 SELECTING FAHRENHEIT(°F) & CELSIUS (°C) DISPLAY
- 12 INTERIOR LIGHTING MODE CHOOSE
- 13 INTERIOR LIGHTING COLOR CHOOSE
- 13 INTERIOR LIGHTING BRIGHTNESS CHOOSE
- 13 DOOR ALARM
- 13 ENERGY SAVING MODE (DEFAULT)
- 14 DEMO MODE
- 14 CARBON FILTER CHANGE
- 14 WIFI CONNECTION
- 14 TO DISABLE THE WIFI FUNCTION
- 15 ERROR CODE

16 CARE AND MAINTENANCE

- 16 CLEANING THE WINE COOLER
- 16 REMOVING THE SHELVES
- 16 Carbon Filter Change
- 17 Defrosting
- 17 Moving Your Wine Cooler
- 17 Power Failure
- 18 Vacation Time
- 18 Disconnecting From Power

19 TROUBLESHOOTING

20 WOOD PANEL INSTALLATION

20 WOOD PANEL DIMENSION

20 INSTALL THE PANEL

22 INSTALL REMOVABLE FRONT GRILLE

- Please removed all packaging, stickers and films from the products surface and clean the product's surfaces with a damp cloth and mild detergent before using for the first time.
- Let the appliance stand upright for approximately **24** hours before connecting it to the power source, which helps to reduce the possibility of a cooling-system malfunction from handling during transportation.

Before using your Wine Coolers, please carefully read this instruction manual in order to maximize its performance. Store all documentation for subsequent use or for other owners. This product is intended solely for household use or similar applications such as:

- the kitchen area for personnel in shops, offices and other working environments
- on farms, by clientele of hotels, motels and other environments of a residential type
- at bed and breakfasts (B&B)
- for catering services and similar applications not for retail sale.

This appliance is intended to be used exclusively for the storage of wine or beverage, any other use is considered dangerous and the manufacturer will not be responsible for any omissions. Also, it is recommended that you take note of the warranty conditions.

ENERGY SAVING AND ECOLOGICAL PROTECTION

Please pay attention to the following special instructions for saving energy and ecological protection:

- (a) The most energy-saving configuration requires shelves to be positioned in the appliance, please refer to the corresponding pictures in the manual.
- (b) Please follow all the instructions in this manual on where and how to store wines in a the appliance for best preservation over the longest period, to avoid food waste;
- (c) Please follow all the instructions in this manual on the recommended setting of temperatures in each compartment for optimum food preservation.
- (d) An estimation of the impact of temperature settings on food waste: for the best storage time of wines, please consult your wine labels; the best storage time may reduce under other un-recommended temperature settings.
- (e) The appliance has no special modes and features that can affect temperatures.
- (f) This appliance is intended to be used exclusively for the storage of

wine

(g) Please follow all the instructions in this manual for the correct installation and end-user maintenance, including cleaning, of the refrigerating appliance;

(h) FOR a free standing appliance: this refrigerating appliance is not intended to be used as a built-in appliance.

(i) This refrigerating appliance is not suitable for freezing foodstuffs.

(j) Access to professional repair: <https://service.temptech.no/>

(k) Ordering spare parts: Please send emails to Service@temptech.no

(l) The minimum period during which spare parts, necessary for the repair of the appliance, are available:

Thermostats, temperature sensors, printed circuit boards and light sources are available for a minimum period of seven years after placing the last unit of the model on the market.

Door handles, door hinges, trays and baskets for a minimum period of seven years and door gaskets for a minimum period of 10 year, after placing the last unit of the model on the market

(m) The minimum duration of the guarantee of the refrigerating appliance offered by the manufacturer, importer or authorised representative:

Minimum guarantee is: 5 years for Norway, Sweden, Finland and Denmark.

(n) For appliances with climate class :

- Extended temperate: 'this refrigerating appliance is intended to be used at ambient temperatures ranging from 10 °C to 32 °C';

- Temperate: 'this refrigerating appliance is intended to be used at ambient temperatures ranging from 16 °C to 32 °C';

- Subtropical: 'this refrigerating appliance is intended to be used at ambient temperatures ranging from 16 °C to 38 °C';

- Tropical: 'this refrigerating appliance is intended to be used at ambient temperatures ranging from 16 °C to 43 °C';

(o) How to find the model information in the product database: Please visit our website <https://temptech.no/> to find the instruction about how to find production information in EU database.

IMPORTANT SAFETY INFORMATION

The Wine Coolers contains a refrigerant gas (R600a: isobutane) and insulating gas (cyclopentane), with high compatibility with the environment, that are, however, inflammable.

We recommend that you follow the following regulations so as to avoid situations dangerous to you:

Before performing any operation, unplug the power cord from the power socket.

- The refrigeration system positioned behind and inside the Wine Coolers contains refrigerant. Therefore, avoid damaging the tubes.
- If in the refrigeration system a leak is noted, do not touch the wall outlet and do not use open flames. Open the window and let air into the room. Then call a service centre to ask for repair.
- Do not scrape with a knife or sharp object to remove frost or ice that occurs. With these, the refrigerant circuit can be damaged, the spill from which can cause a fire or damage your eyes.
- Do not install the appliance in humid, oily or dusty places, nor expose it to direct sunlight and to water.
- Do not install the appliance near heaters or inflammable materials.
- Do not use extension cords or adapters.
- Do not excessively pull or fold the power cord or touch the plug with wet hands.
- Do not damage the plug and/or the power cord; this could cause electrical shocks or fires.
- It is recommended to keep the plug clean, any excessive dust residues on the plug can be the cause fire.
- Do not use mechanical devices or other equipment to hasten the defrosting process.
- Absolutely avoid the use of open flame or electrical equipment, such as heaters, steam cleaners, candles, oil lamps and the like in order to speed up the defrosting phase.
- Do not use or store inflammable sprays, such as spray paint, near the Wine Coolers. It could cause an explosion or fire.
- Do not use electrical appliances inside the food storage compartments, unless they are of the type recommended by the manufacturer.
- Do not place or store inflammable and highly volatile materials such as ether, petrol, LPG, propane gas, aerosol spray cans, adhesives, pure alcohol, etc. These materials may cause an explosion.
- Do not store medicine or research materials in the Wine Coolers. When the material that requires a strict control of storage temperatures is to be stored, it is possible that it will deteriorate or an uncontrolled reaction may occur that can cause risks.
- Maintain the ventilation openings in the appliance enclosure or in the

built-in structure, free of obstruction.

- Do not place objects and/or containers filled with water on the top of the appliance.
- Do not perform repairs on this Wine Coolers. All interventions must be performed solely by qualified personnel.
- This appliance can be used by children aged from 8 years and above and by persons with reduced physical, sensory or mental capabilities or with a lack of experience and knowledge; provided that they have been given adequate supervision or instruction concerning how to use the appliance in a safe way and understand the hazards involved.
- Children should not play with the appliance. Cleaning and user maintenance should not be made by children without supervision
- This appliance is not intended for use by persons (including children) with reduced physical, sensory or mental capabilities, or lack of experience and knowledge, unless they have been given supervision or instruction concerning use of the appliance by a person responsible for their safety. Children should be supervised to ensure that they do not play with the appliance.
- The appliance must be positioned so that the plug is accessible
- If the supply cord is damaged, it must be replaced by the manufacturer, its service agent or similarly qualified persons in order to avoid a hazard.
- The appliance shall not be installed in the laundry
- GWP for R600a: 3
- Do not store explosive substances such as aerosol cans with a flammable propellant in this appliance.
- **WARNING:** Keep ventilation openings, in the appliance enclosure or in the built-in structure, clear of obstruction.
- **WARNING:** Do not use mechanical devices or other means to accelerate the defrosting process, other than those recommended by the manufacturer.
- **WARNING:** Do not damage the refrigerant circuit.
- **WARNING:** Do not use electrical appliances inside the food storage compartments of the appliance, unless they are of the type recommended by the manufacturer

SCRAPPING OLD APPLIANCES

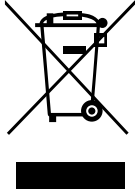

This appliance is marked according to the European directive 2012/19/EU on Waste Electrical and Electronic Equipment (WEEE).

WEEE contains both polluting substances (which can cause negative consequences for the environment) and basic components (which can be re-used). It is important to have WEEE subjected to specific treatments, in order to remove and dispose properly all pollutants, and recover and recycle all materials.

Individuals can play an important role in ensuring that WEEE does not become an environmental issue; it is essential to follow some basic rules:

- WEEE should not be treated as household waste;
- WEEE should be handed over to the relevant collection points managed by the municipality or by registered companies. In many countries, for large WEEE, home collection could be present.

In many countries, when you buy a new appliance, the old one may be returned to the retailer who has to collect it free of charge on a one-to-one basis, as long as the equipment is of equivalent type and has the same functions as the supplied equipment.

■ Conformity

By placing the  marking on this product, we declare, on our own responsibility, compliance to all of European safety, health and environmental requirements stated in the legislation for this product.

■ Energy Saving

- Always ensure good ventilation. Do not cover ventilation opening or grille.
- Always keep fan louvers clear.
- Do not place appliance in areas of direct sunlight or close to a stove, heater or similar object.
- Open or keep the doors open as little as possible
- Remove dust present on the rear of the appliance

■ Service

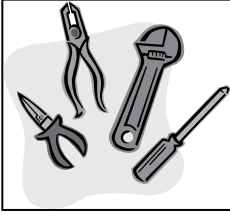

- You should not attempt to repair the appliance yourself, as this could cause injury or a more serious malfunction. If you require a service call then please contact the Customer Care Department

INSTALLATION

The following pictures only show description of appliance. The dimension and shelf quantity may differ among the models of the same series.

■ SKX6070DKF

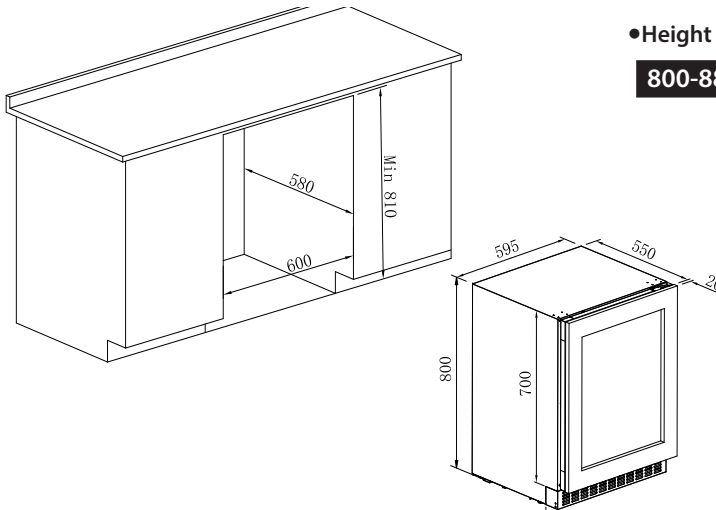

- Height Adjustable:

800-880mm

■ SKX6070DRB

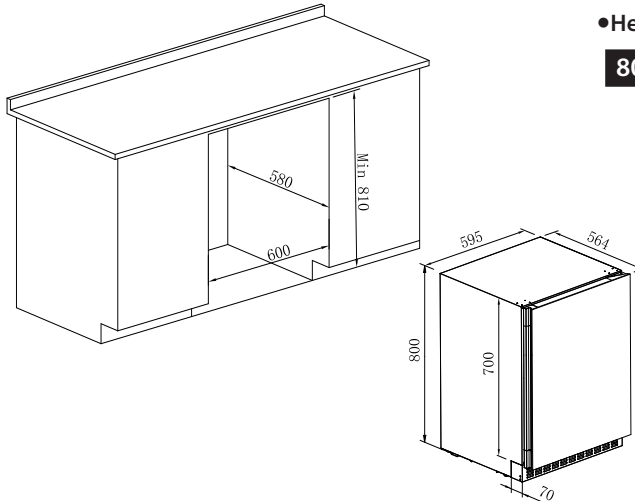

● Height Adjustable:

800-880mm

ACCESSORY INSTALLATION BEFORE OPERATING

■ UNPACKING AND CLEANING THE WINE COOLER

- Remove the exterior and interior packing materials.
- Let the appliance stand upright for approximately **24 hours** before connecting it to the power source, which helps to reduce the possibility of a cooling-system malfunction from handling during transportation.
- Use a soft cloth to clean the interior surface with lukewarm water.

IMPORTANT: The front louver at the base of the appliance is for ventilation. Nothing should be placed in front of this front louver; otherwise your Wine Cooler may not operate properly.

o A decorative plinth can be fitted to the front of the base vent, a cut-out should be made in the plinth with bigger size than the front louver. The cut out is required whether the front louver is removed or not.

■ Adjusting the height and levelling off your wine cabinet

- o The appliance is equipped with adjustable feet, so that the height may be adjusted to level the cabinet on uneven floor surfaces.
- o We recommend that two people carry out this procedure.

o The height must be adjusted prior to building the appliance into the housing unit and it should be set at such a height that the top panel of the appliance fits exactly below the kitchen worktop.

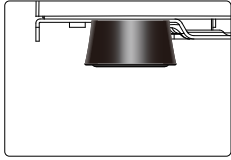

- o Tilt the appliance approximately 60° to allow access to the adjustable feet.
- o Take care to ensure the cabinet is supported at all times.

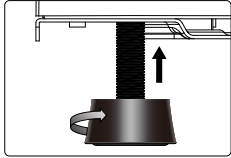

- o Twist the foot into a suitable position to level the cabinet.

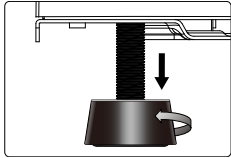

- o Repeat these steps for the other adjustable feet.

IMPORTANT: If the appliance is not level, then the door and door seal may be affected.

IMPORTANT: Do not move the appliance when the feet are adjusted high.

BOTTLE LOADING DRAWING

The following pictures only show description of appliance.

■ SKX6070DRB/DKF

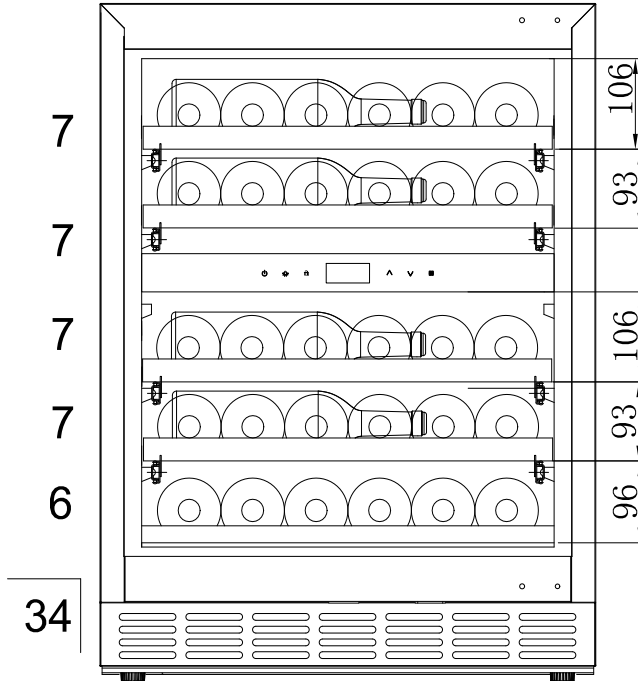

OPERATING THE WINE COOLER

■ WORKING CLIMATE

- The appliance is designed for operating from SN to N climate (see below climate class chart). It is recommended to maintain the ambient around 22-25°C which helps the appliance working with low power consumption.

Klimaklasse	Romtemperatur
SN	10 - 32 °C (50°F-90°F)
N	16 - 32 °C (61°F-90°F)
ST	16 - 38 °C (61°F-100°F)
T	16 - 43 °C (61°F-109°F)

- If the ambient temperature is above or below the designed climate range, the performance of the unit may be affected. For example, the appliance operating in extreme cold or hot conditions may cause interior temperatures to fluctuate, and the temperature set 5-20°C may not be reached sometimes.

■ WINE STORAGE

- The standard shelves are designed perfectly for Bordeaux bottle storage. The maximum loaded bottles may vary subject to the different size or dimension wine bottles you store.
- To prevent damaging the door gasket, make sure to have the door opened fully all the way before pulling the shelves out.
- Please store wine in sealed bottles.
- Do not cover the shelves with aluminum foil or any other shelf material which may prevent air circulation.
- Should the wine cooler be left empty for long periods it is suggested that the appliance is unplugged, and after careful cleaning, leave the door ajar to allow air to circulate inside the cabinet in order to avoid possible condensation, mold or odours forming.
- If the wine cooler is left empty for long periods, switch off, defrost, clean, dry, and leave the door open to prevent mould developing within the appliance.
- Pay attention to the recommended/preferable storage time of the wines you bought
- Opening the door for long periods can cause a significant increase of the temperature in the compartments of the appliance. The recommended temperatures for chilling, storing your wines is as below, please choose zones and temperatures accordingly..
- Recommended temperatures for chilling/storing your wines.

Wine Type	Recommender Temp.
Red Wines	15 - 18°C (59°F-64°F)
DryWhite Wines	9 - 14°C (48°F-57°F)
Rose Wines	10 - 11°C (50°F-52°F)
Sparkling Wines	5 - 8°C (41°F-46°F)

CONTROL PANEL IN CABINET

■ Dual zone control panel

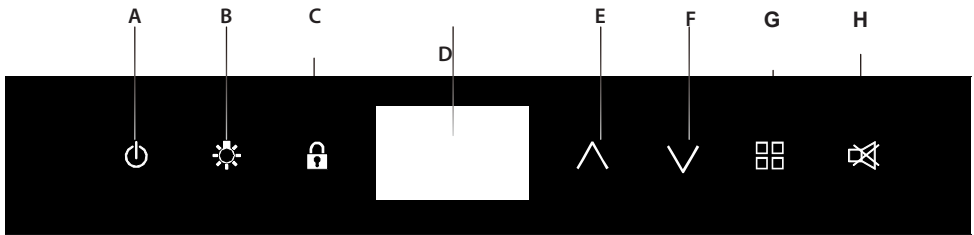

A: Power B: Lighting C: Lock/Unlock D: Display window E: Temp plus F: Temp minus
 G: Zone select H: Mute

■ POWER ON/OFF CONTROL

- When the appliance is plugged in to a power outlet, it powers on automatically.
- Touch the power mark (⏻) and hold for **3 seconds** to turn off (or turn on) the appliance.



Warning: To avoid damaging the compressor, please do not turn on the appliance again within **5 minutes** after you turn it off.

■ LOCKING/UNLOCKING THE CONTROL PANEL

For Dual Zone

- To lock/unlock the control panel, touch the lock mark for 3 seconds, when locked/unlocked a buzz sound will be heard.

Under the locked condition, the control panel will not react to any touching order for Lighting On/Off and Temperature Setting.

■ TEMPERATURE SETTING

- The default temperature setting ranges for dual zone are : 5-12 °C (41-54 °F) for the upper zone and 12-20 °C (54-68 °F) for the bottom zone.
- For dual zone, you need to select the set zone by touching the zone select mark before touching the mark temp plus or temp minus mark to set the desired temperature. The zone temperature will flash when it is ready to be set.

■ TEMPERATURE DISPLAY(SET TEMPERATURE DEFAULT)

- The default temperature display is set temperature.







For Dual Zone

- Under the unlocked condition, press the lightning and lock marks together and holds for 3 seconds, the real temperature will be displayed and blinking for 5 seconds, and after 5 seconds, will return back to set temperature.

■ SELECTING FAHRENHEIT(°F) & CELSIUS (°C) DISPLAY

- Under the unlocked condition, press the temp plus and temp minus mark and holds for 3 seconds to switch from celsius to fahrenheit temp.

■ INTERIOR LIGHTING MODE CHOOSE

- Under the unlocked condition, press the lightning mark and mute mark together and holds for 3 seconds to enter the light mode choose, press temp plus or temp minus key to choose the light mode.
- **Door contactor mode** : default mode. When the door is open, the door open icon  and inner lights will be on. When close the door, the door open icon  and the inner lights will be off.
- **Automatic mode** : When the door is open, the door open icon  and inner lights will be on. When close the door, the door open icon  and the inner lights will be off after 15 minutes.
- **Permanent mode** : The lights' on/off is only controlled by control panel, free from the door contactor. Under permanent mode: short press lightning mark to control





lights on/off.

- **Note:** each light mode is independent.





■ INTERIOR LIGHTING COLOR CHOOSE

- Under the unlocked condition, press the lightning mark and holds for 3 seconds to enter the light color choose, press temp plus or temp minus key to choose the light color between "A" "C" "W".
- **"W"**: default color. Warm white.
- **"C"**: colde white.
- **"A"**: amber

■ INTERIOR LIGHTING BRIGHTNESS CHOOSE

- Under the unlocked condition, short press the lightning mark to choose the light brightness.
- **Door contactor mode** : When the door is open, the door open icon  and inner lights will be on(100%), short press lightning mark, then the light brightness will be changed from 75%-50%-25%-100%, and repeat.
- **Automatic mode** : When the door is open, the door open icon  and inner lights will be on(100%), short press lightning mark, then the light brightness will be changed from 75%-50%-25%-100%, and repeat.
- **Permanent mode** : Short press lightning mark, then the light brightness will be changed from onz(100%)- 75%-50%-25%-off(0%)-on(100%), and repeat.

■ DOOR ALARM

- When the door is open, the door open icon  and inner lights will be on.
- When the door is open for 3 minutes, and the compressor and all fans will be stopped. The alarm is ringing, with a BI-BI sound every 1.5 seconds. Icon  will be flashing, press the mute mark to disable the alarm sound and icon  will be on.
- When the door is closed, door open icon  will be disappeared.

■ ENERGY SAVING MODE(DEFAULT)



- The screen backlights will reduce to dimmer after 20s no action on screen, touch any key, the LCD screen will light again.

■ DEMO MODE

For Dual Zone



- Under the unlocked condition, press the lightning and zone select mark together and holds for 3 seconds to enter/exit the demo mode.
- Under the demo mode, the icon  will light up. The compressor, fans and heaters will be stopped, only light is working. All alarm and Wifi connection will be invalid.

■ CARBON FILTER CHANGE

- When the unit is powered on, the countdown from 365 days will start, when the day reaches "0" day, the carbon filter icon  will displayed to indicate that the it needs to be changed.
- Under the unlocked condition, after you changed the carbon filter, press the lightning and temp minus mark together and holds for 3 seconds to reset the carbon filter, the icon  will flash for 5 seconds, and then disappear to show the reset is done.

■ WIFI CONNECTION

For Dual Zone

- Under the unlocked condition, press the lock and temp plus marks together and holds for 3 seconds to reset the wifi.
-  is flashing, waiting for pairing. Or failed in pairing.
-  is on, successfully connected.
- When you failed in pairing, you must reset the wifi again before the next pairing.

■ TO DISABLE THE WIFI FUNCTION

For Dual Zone

- Under the unlocked condition, press the lock and temp minus marks together and holds for 3 seconds to disable the wifi connection, and the wifi icon  will disappear.

■ ERROR CODE**For Dual Zone**

Error Code	Description	Visual
E1	Sensor loose in the upper zone	Yes
E2	Sensor loose in the lower zone	Yes
E3	Sensor in short-circuited in the upper zone	Yes
E4	Sensor in short-circuited in the lower zone	Yes
E5	High temp in the upper zone	Yes
E6	High temp in the lower zone	Yes
E7	Low temp in the upper zone	Yes
E8	Low temp in the lower zone	Yes

CARE AND MAINTENANCE

■ CLEANING THE WINE COOLER

- Turn off the power, unplug the appliance, and remove all items including shelves.
- Wipe the inside surfaces with a sponge and baking soda solution. The solution should be about 2 tablespoons of baking soda to 1 quart (approx. 1 litre) of warm water.
- Wash the shelves with a mild detergent solution. Allow wooden shelves to dry before placing back into the wine cooler.
- Wring excess water out of the sponge or cloth when cleaning area of the controls, or any electrical parts.
- Wipe the outside cabinet with warm water and mild liquid detergent. Wipe dry with a clean soft cloth.
- Do not use steel wool or steel brush on the stainless steel. These will scratch the stainless steel with steel particles and rusting may occur.

■ REMOVING THE SHELVES

- Before removing a Shelf from the appliance, it is necessary to remove all the bottles on the Shelf ;
- For a model without Telescopic Rail, move the shelf to the position where the cut of the wooden shelf is directly under the plastic stopper and lift the wooden shelf. Please ensure these are replaced when the shelf is put back.
- For a model with Telescopic Rail, pls. lift the whole Shelf upwards horizontally to get it off from the 4 Locating Pins of Telescopic Rail.

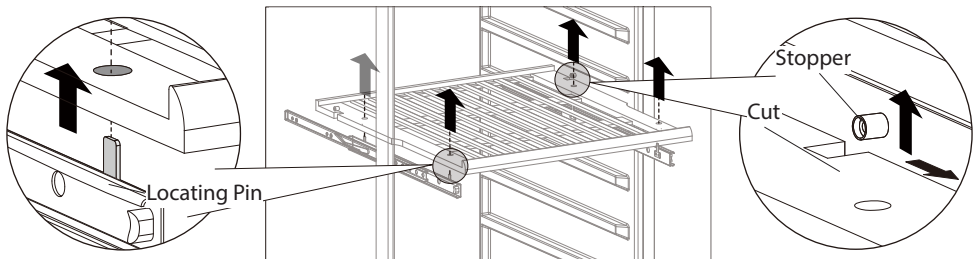

■ Carbon Filter Change

A good ambient air quality is important for wine maturing. The Carbon Filter is very helpful to absorb odor and improve air quality. For the models with Carbon Filter, we suggest to replace it once a year. Pls. contact your dealer to get the filter.

Removing the Carbon Filter:

- o Hold the Carbon Filter and turn it 90° to the left or right to Remove it;

Reinstalling the Carbon Filter:

- o Hold the Carbon Filter and turn it 90° to the left or right until it clicks into place.



■ Defrosting

- o Defrosting occurs automatically inside of the Wine Cooler during operation. The defrost water is collected by the evaporating tray and evaporates automatically.
- o The evaporating tray and defrost water drain hole should be cleaned periodically. This will prevent water from collecting in the bottom of the Wine Cooler, instead of flowing down the defrost drainage channel and drain hole.
- o You can also pour a small amount of water down the drain hole to clean inside of it.
- o You should be careful to make sure that wine bottles do not touch the rear wall of the appliance, as this can interrupt the automatic defrosting process and deflect water into the base of your Wine Cooler.

■ Moving Your Wine Cooler

If you need to move your Wine Cooler to another location you should follow the steps outlined below.

- o Remove all items from the Wine Cooler.
- o Securely tape down all loose items such as the shelves inside of the appliance.
- o Turn the adjustable foot up to the base to avoid damage.
- o Tape the door closed.
- o Ensure the appliance stays secure in the upright position during transportation. Also protect the outside of the appliance with a blanket or similar item.

■ Power Failure

- o If power is cut to the appliance, for a few hours it will be able to maintain the temperature inside the cabinet. Providing that the number of times that the door is opened is kept to a minimum.
- o If the power cut is for longer than a few hours, then you will need to store the contents in an alternate location to prevent them being affected by

temperature rise.

IMPORTANT: If the appliance is unplugged, the power is lost or turned off you must wait 5 minutes before restarting the Wine Cooler. If you attempt to restart before this time delay, the compressor could be damaged.

■ Vacation Time

Short vacations: Leave the Wine Cooler in operation for holidays of less than 3 weeks.

Long vacations:

- o If your appliance is not going to be in use for a period of time, you should remove the bottles of wine and switch off the appliance
- o The interior should be cleaned with a solution of bicarbonate of soda and lukewarm water.
- o The interior should then be thoroughly dried.
- o To prevent mould growth, the door should be left slightly ajar.

■ Disconnecting From Power

- o If the unit is unplugged, or there is a power cut, you must wait for 5 minutes before restarting. Attempting to restart the Wine Cooler before 5 minutes has elapsed, may cause it not to function.

TROUBLESHOOTING

If you feel the appliance is not working properly, follow these instructions to try to see if you can solve the problem simply by yourself before calling for service.

No.	PROBLEM	PROBLEM POSSIBLE CAUSE / MEASURE
1	The wine cooler does not operate	Not plugged in· The appliance is turned off· The circuit breaker tripped or a blown fuse·
2	The wine cooler is not cold enough	Check the temperature control setting· External environment may require a higher setting· The door is opened too frequently· The door is not closed completely· The door gasket does not seal properly·
3	Automatically turn on and turn off frequently	The room temperature is hotter than normal· A large amount of contents has been added to the wine cooler· The door is opened too frequently· The door is not closed completely· The temperature control is not set correctly· The door gasket does not seal properly·
4	The lighting does not work	Not plugged in· The circuit breaker tripped or a blown fuse· The lighting is turned off·
5	Too much vibration	Check to assure that the appliance is level· Check to assure no parts inside the cabinet or in the compressor chamber are loose·
6	The wine cooler seems to make too much noise	The rattling noise may come from the flow of the refrigerant which is normal· As each cycle ends, you may hear gurgling sounds caused by the flow of refrigerant· Contraction and expansion of the inside walls may cause popping and crackling noises· The appliance is not level·
7	The door will not close properly·	The wine cooler is not level· The door was reversed and not properly installed· The gasket is dirty· The shelves are out of position·

WOOD PANEL INSTALLATION

■ WOOD PANEL DIMENSION

- Please cut the wood panel oexactly the same as below drawing

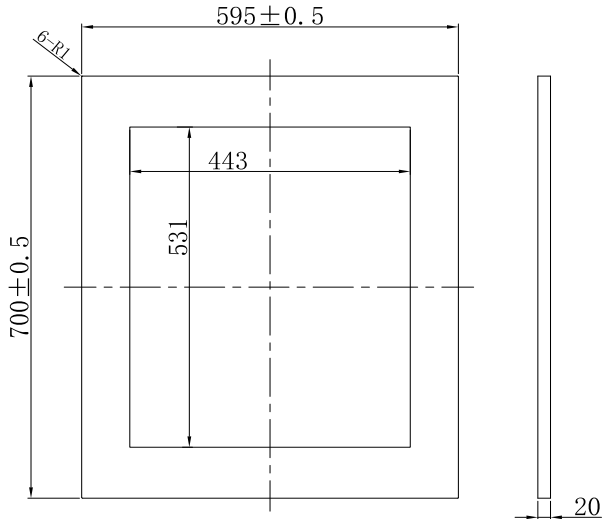

■ INSTALL THE PANEL

- Remove the gasket from the door

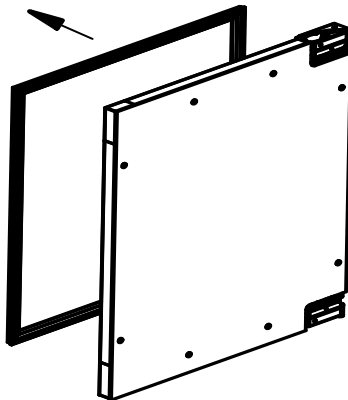

- Reinstall the 4 side screws in half

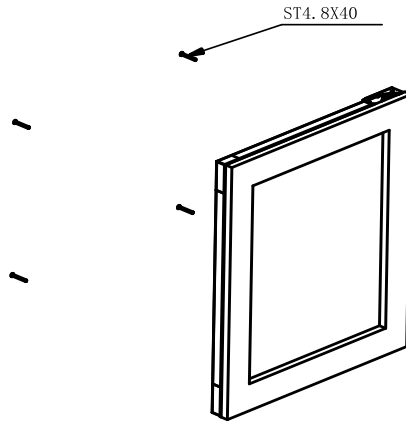

- Hang the wood panel on the door, and move it up or down to its correct position.

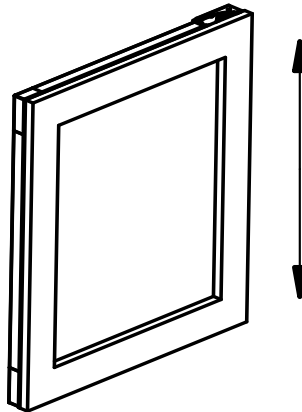

- Fasten tight the top and bottom screws.

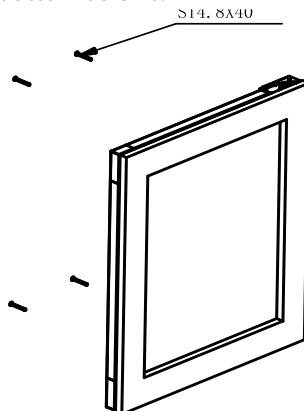

- Install back the gasket.

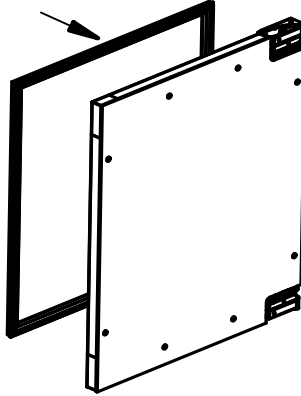

INSTALL REMOVABLE FRONT GRILLE

The plinth/grille for this appliance comes packaged inside and can be fitted if desired. Follow these steps to do so:

1. Locate the plinth (packaged inside the appliance)
2. Remove the four screws from (two on each side of) the plinth section, but take care to support both sections to prevent the adjustable section from falling away. Remove the adjustable front section and place this somewhere safe.
3. With the help of another individual, make sure the wine cooler is secure and tilt it backwards to gain full access to the area below the door. Make sure that the door is kept closed at all times during this process in order to avoid damage to the door and appliance.
4. If present, remove the two screws shown by arrows and marked as 'A' in Fig. 14. Then, locate the four black fitting screws. These are packaged inside the appliance with the door reversing hinge.
5. If present, remove the screws shown by arrows and marked as 'B' in Fig. 15. These are not needed.
6. Offer up the plinth, ensuring it is the same way up as per Fig. 16. Then, using a (magnetic tipped) screwdriver, insert two of the black fitting screws through the oval access holes (shown in Fig. 16) and tighten them.
7. Install a (black fitting) screw into each of the two lower holes (shown in Fig. 16). This

will help to secure the plinth to the underside of the wine cooler.

8. Adjust the wine cooler feet so that you achieve the desired height for the cooler. If needed, re-attach the extendable plinth section with the four screws that were removed in step 2. Stand the wine cooler up steadily- if the extendable section will foul the floor or similar, remove it. Allow the wine cooler to stand for 24 hours before plugging it in. This will help to prevent damage to the system.

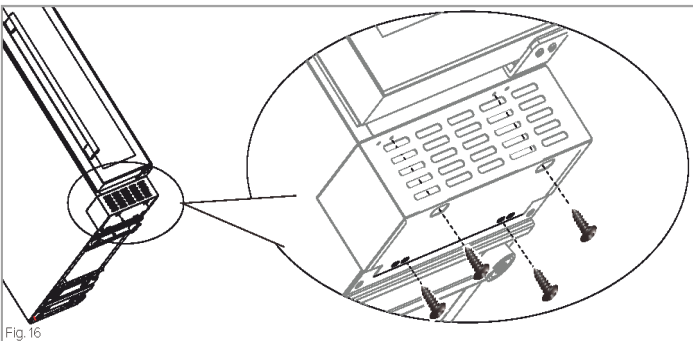
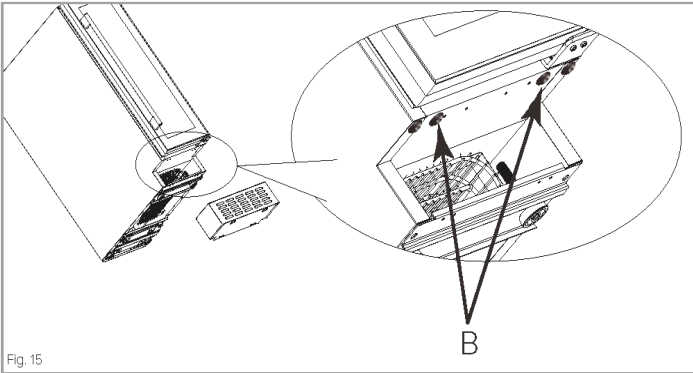
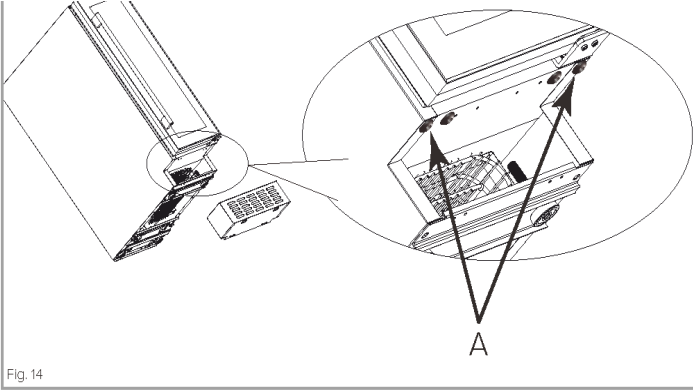

-END-